

30 Amp Power Relay

UL E86876

PC730



FEATURES

- ¼ Inch Male Quick Connect Terminals
- Up to 30 Amp Switch Capacity
- Up to 1½ Horsepower Rating
- Smallest 30 Amp 2 Pole Rating
- Top or Side Flanged Case or PC Mounting
- 2A or 2C Contact Configuration



UL / cUL RATINGS

Contact Form	2A DPST N.O. 2C DPDT	
Rated Load	Voltage	Amps
General Purpose, 6K cycles, 40°C	250VAC	30A
General Purpose, 6K cycles, 40°C	277VAC	20A
General Purpose, 6K cycles, 40°C	28VDC	20A
Resistive, 6K cycles, 40°C	250VAC	30A
Resistive, 6K cycles, 40°C	277VAC	20A
1-½ hp	240VAC	
1 hp	120VAC	

CHARACTERISTICS

Insulation Resistance	500 MΩ min. at 500 VDC
Dielectric Strength	1500 Vrms, between contacts 2500 Vrms, between coil & contacts
Power Consumption	DC Coil : 1.8W; AC Coil : 4VA
Solderability	260°C 5 s ± 0.5 s
Operating Temperature	-40°C to 85°C
Storage Temperature	-40°C to 85°C
Shock Resistance	10g functional
Vibration Resistance	2mm double amplitude 10~55Hz
Weight	70g

CONTACT DATA

Maximum Switching Power	7500 VA
Maximum Switching Voltage	300VAC, 36VDC
Maximum Continuous Current	30 A
Material	AgCdO
Initial Contact Resistance	100 mΩ max.
Service Life	Mechanical 1 x 10 ⁷ operations Electrical 1 x 10 ⁵ operations

Values can change due to the switching frequency, desired reliability levels, environmental conditions, and in-rush current levels. It is recommended to test to actual load conditions for the application. It is the users responsibility to determine the performance suitability for their specific application. The use of any coil voltage less than the rated coil voltage may compromise the operation of the relay.

ORDERING INFORMATION

Example	PC730	-2C	-C1	-120A		
Model:	PC730					
Contact Form:	2A 2C					
Mounting Version:	C1 = Side Flange C3 = Top Flange P = PC Pins					
Coil Voltage:	12A = 12VAC 12D = 12VDC 24A = 24VAC 24D = 24VDC 48A = 48VAC 48D = 48VDC 120A = 120VAC 110D = 110VDC 208A = 208VAC 220A = 220VAC 277A = 277VAC					
RoHS Compliance:	Nil = RoHS Compliant					
Insulation:	Nil = Class B					

COIL DATA

Voltage Type	Coil Voltage		Resistance $\Omega \pm 10\%$	Must Operate Voltage Max (VDC)	Must Release Voltage Min (VDC)
	Rated	Max			
DC 1.8W	12	13.2	72	9	1
	24	26.4	288	18	2
	48	52.8	1152	36	5
Voltage Type	Coil Voltage		Resistance $\Omega \pm 10\%$	Must Operate Voltage Max (VAC)	Must Release Voltage Min (VAC)
	Rated	Max			
AC 4.0VA	12	13.2	13	9.6	4
	24	26.4	48	19	7
	48	52.8	202	38	14
	120	132	1206	96	36
	208	228	3623	166	62
	220	242	4235	176	66
	240	264	4824	192	72
	277	305	5683	222	83

NOTE : The use of any coil voltage less than the rated voltage will compromise the operation of the relays. Must Operate Voltage is listed for test purposes only and is not to be used as design criteria. Pickup and release voltages are for test purposes only and are not to be used as design criteria.

DIMENSIONS mm (inches)

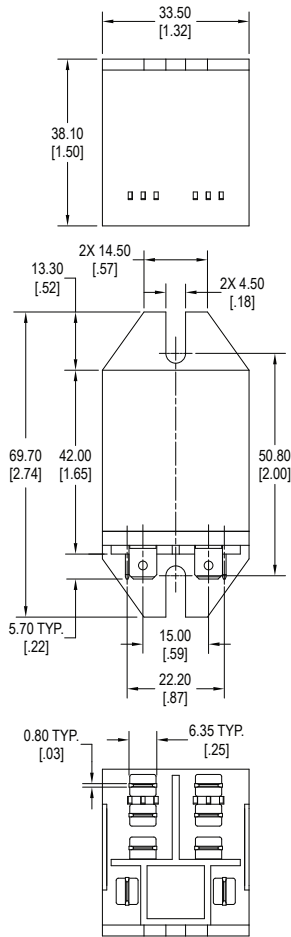

C1 - Side Flange

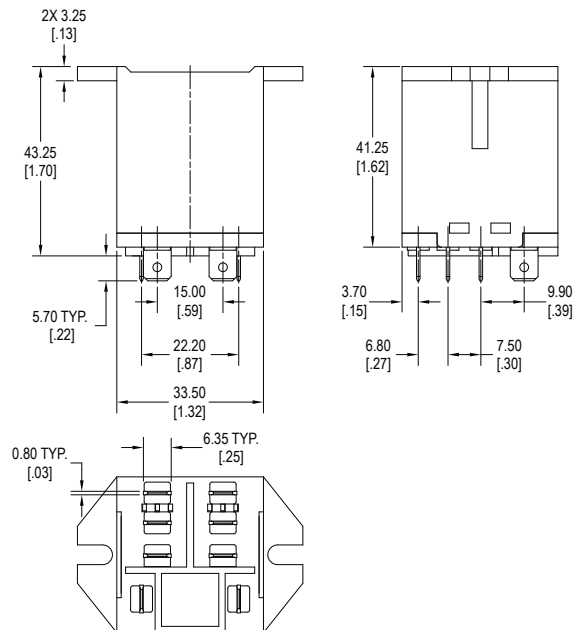
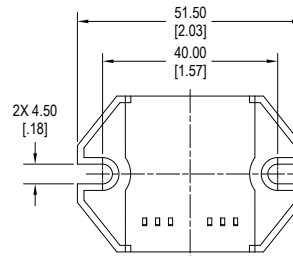

C3 - Top Flange



20550 Commerce Blvd, Rogers, MN 55374 USA
Sales (763) 535-2339

Dimensions are shown for reference purposes only.
PC730 Rev D 11/2022

DIMENSIONS mm (inches)

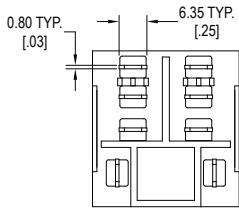
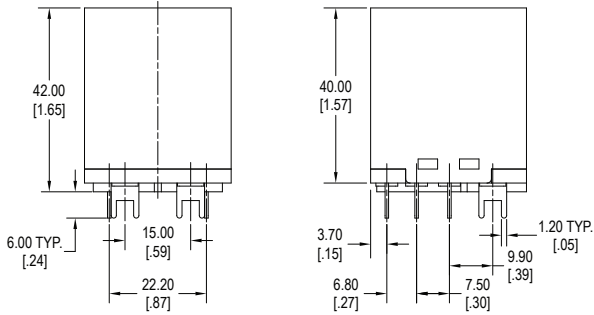
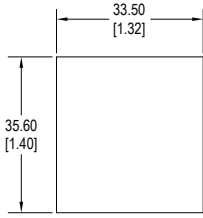

P - PC Terminal

TERMINALS mm (inches)

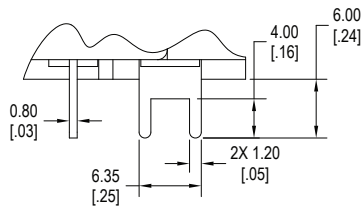

Quick Connect

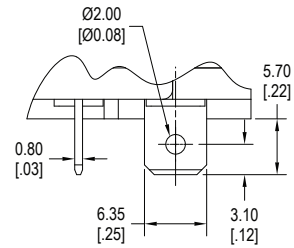

PC Pins

SCHEMATICS *Bottom Views*

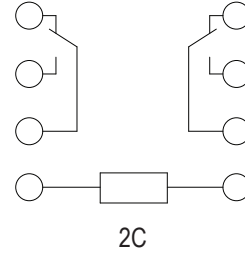
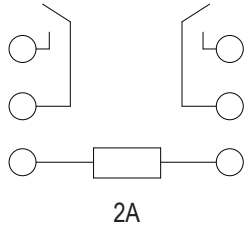

PC LAYOUT

